

# Diplexer per 2 m/70 cm

I was delighted to read the short translation of my article called "Diplexer for 2 m/70 cm" in the 145<sup>th</sup> issue of [AMSAT-UK OSCAR NEWS](#). (The original article appeared in in [CQ-DL 7, 1998](#).) Because of the repeated translations and lack of space I found the following wrong statement written by OZ1MY, *Ib* OM in the article.

"The curve, which averages around -10 dB, is the Return Loss at the common input to the diplexer."

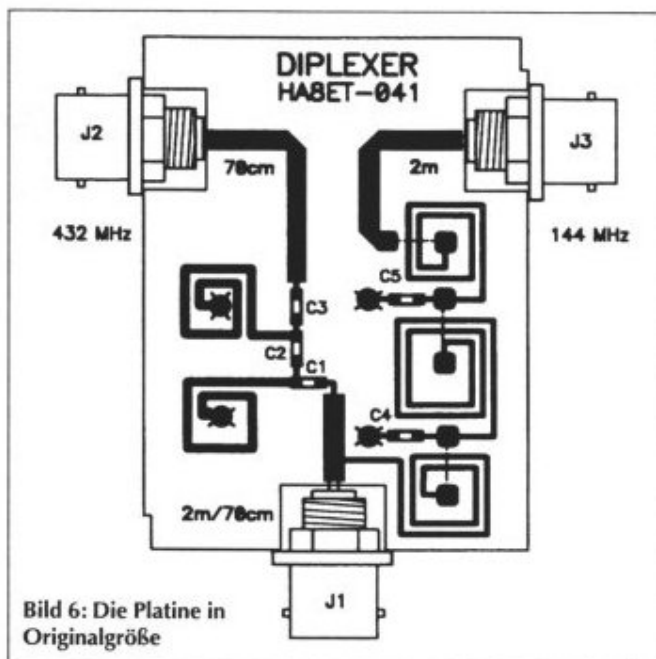

Parameter	HP	LP
Dämpfung bei 145 MHz [dB]	min. 31	max. 0,5
Dämpfung bei 432 MHz [dB]	max. 0,6	min. 39
Rückflußdämpfung [dB]	min. 25	min.29
$f_{-40}$ dB [MHz]	125	300
$P_{max}$ bei C-Typ 1206, 63 V [W]	10	10
$P_{max}$ bei C-Typ ATC-100, 250 V [w]	50	50

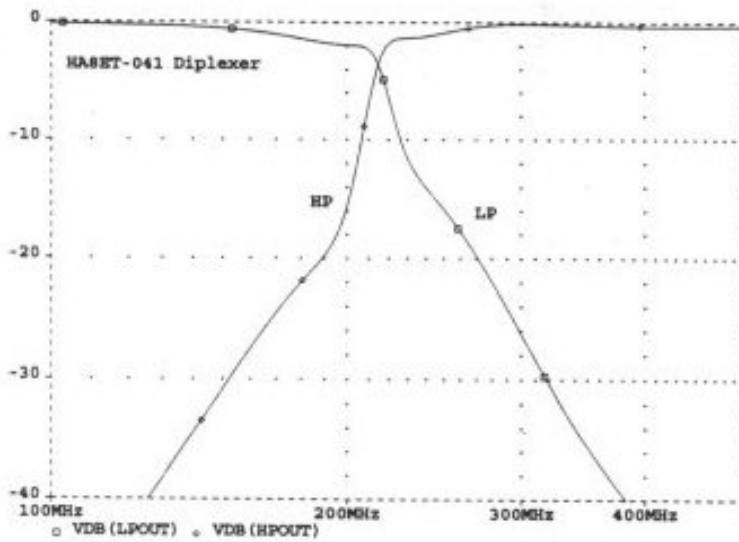

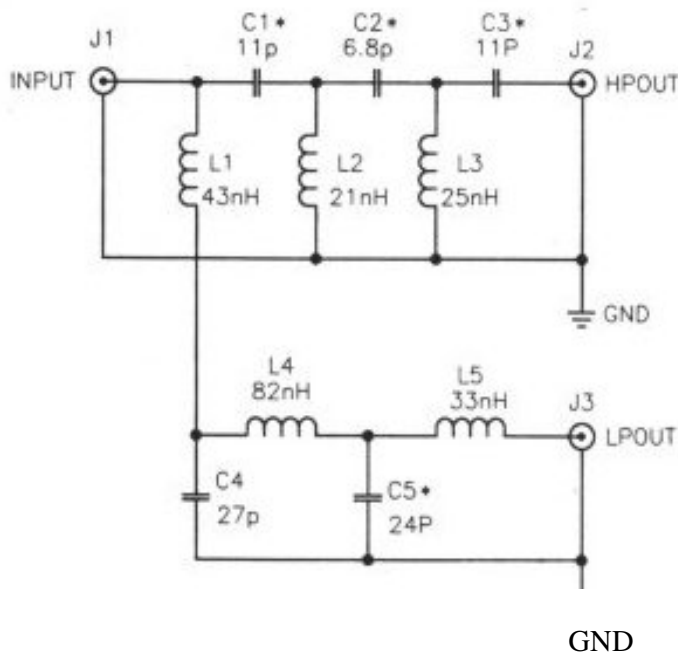

**F**our years ago I set myself to present a simplified filter-designing for HAMs. I planned the filters of the diplexer with free working demos and low cost programs. (HP: AppCAD, ARRL: SVCfilt, MICROSIM: DesignLab Evaluation 7.1, ACCEL: Tango PCB Eval.) These programs are unable to work properly with the Distributed Microstrip Rectangular Spiral Inductors. That's why after the theoretical inductors and capacitors values measurements they had to be modified to a little degree. So the final Layout formed in this way.

**I**n the case of professional EDA Softwares used nowadays we don't need such modifying. For example: AGILENT EEsof EDA, ANSOFT: Serenade, -Ensemble, -HFSS, APLAC 7.6, CST Microwave Studio, EAGLEWARE: Genesys 7.5, IE3D, KCC, Microwave Office 4.1, OPTOTEK MMICAD, Sonnet USA, etc. These programs take both the parasite capacitors and the coupling between the turns of the inductors into consideration.

**I** enclose the results of the diplexer Return Loss measured on the common input port in this article. So you can produce good filters with practically free programs as well if you constantly check the measuring results, and modify the values of the elements accordingly.

**I** used the following Agilent Technologies (Hewlett Packard) instruments for the measuring:

- HP ESA-L1500A (E4411A) Spectrum Analyzer with Tracking Generator
- HP 86205A High directivity RF Bridge (300 kHz...6 GHz)
- HP E44444A BenchLink Spectrum Analyzer Software
- HP VXI Card and software
- Pentium III. PC 700 MHz



11:24:44 JUL 09, 2001

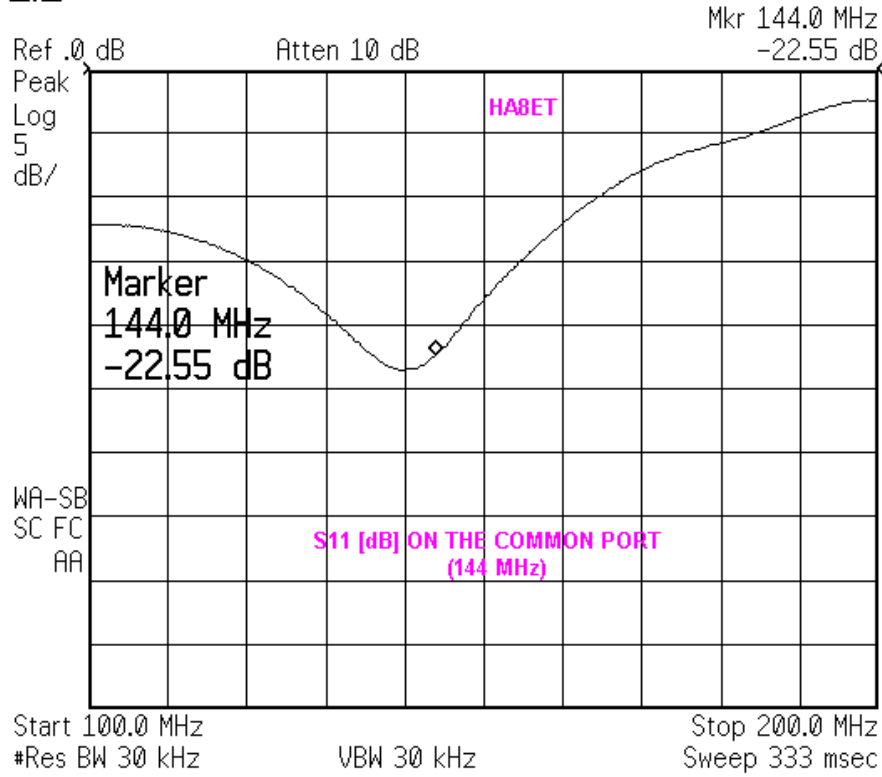

**Search**

Max Pk → CF

Mkr → CF

Mkr → Ref Lvl

Next Peak

Next Pk Right

Next Pk Left

Peak Excursn

1 of 2 ↓

**Figure 1.** The Return Loss at the common input to the diplexer on 144 MHz  $S_{11} > 22$  dB

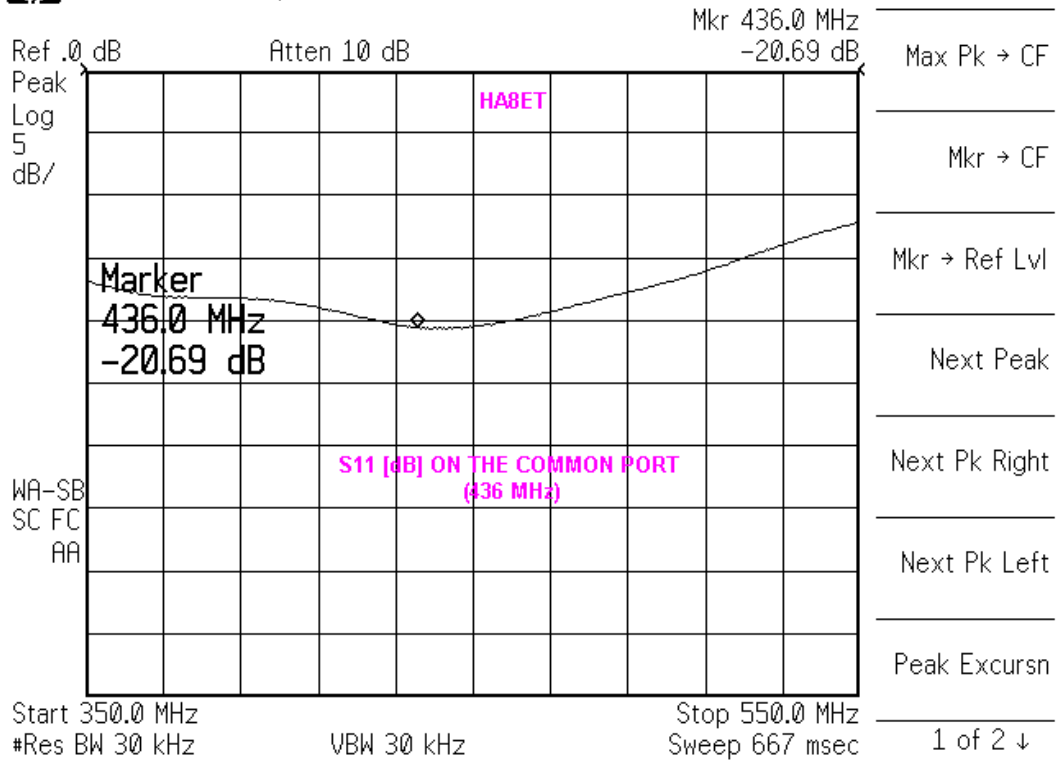

**Figure 2.** The Return Loss at the common input to the diplexer on 436 MHz. S11 >20 dB

11:40:17 JUL 09, 2001

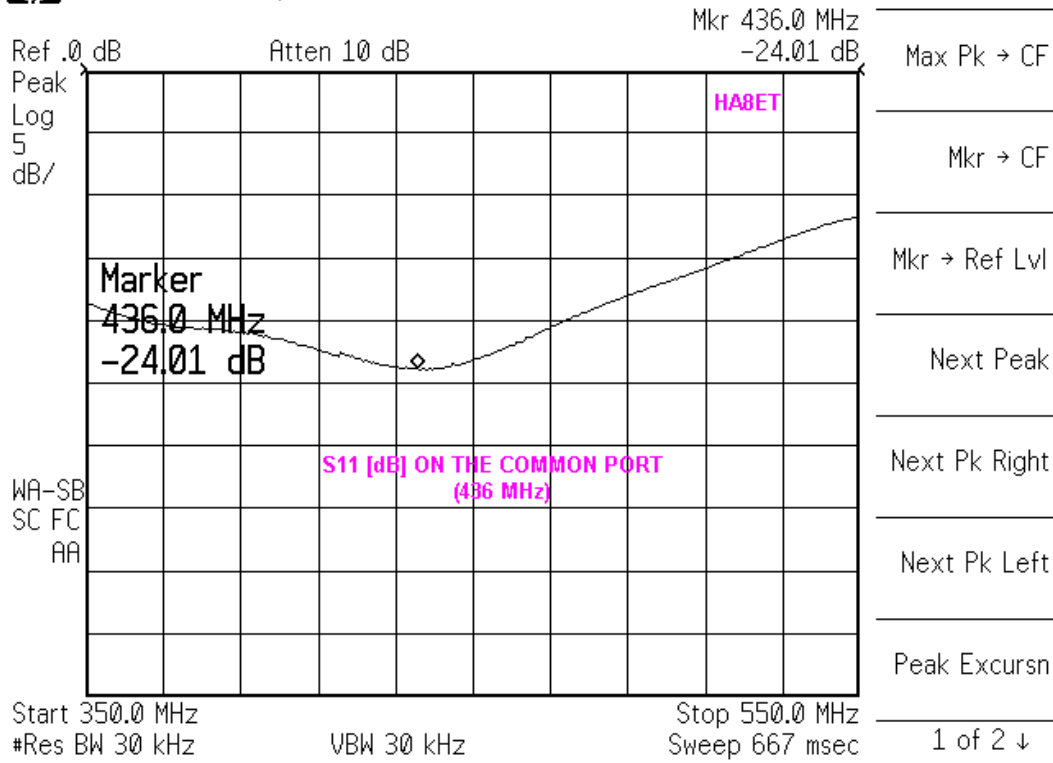

*Figure 3. At the mounting of the BNC-female (Shown by figure 4.) S11 > 24 dB!*

**It was published: AMSAT UK OSCAR NEWS Oct 2001 pp. 39-41**

By Dipl. Ing. Gyula Nagy, HA8ET

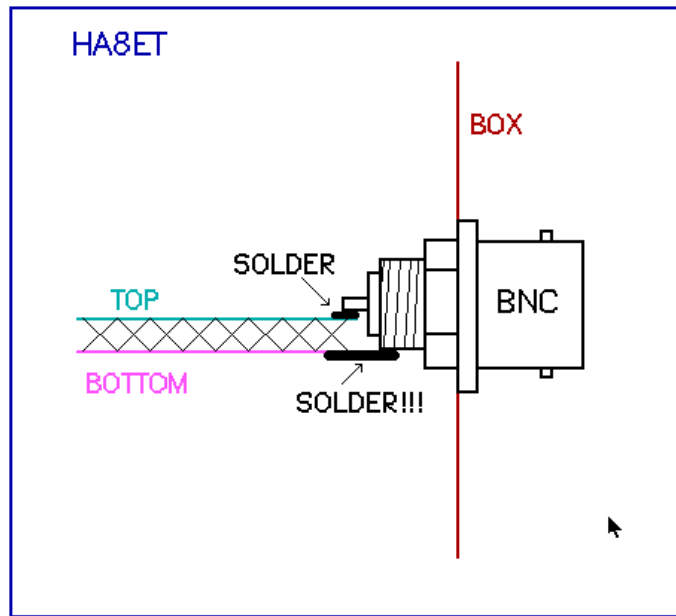

*Figure 4. Proposed mounting of the BNC-female*